

# 2015

JEAN MÜLLER   
THE NAME FOR SAFETY

## C|O|S|M|O<sup>®</sup> 60mm母线系统

## *C|O|S|M|O<sup>®</sup> 60mm busbar-system*



C|O|S|M|O®

C|O|S|M|O®

## C|O|S|M|O® 60mm 母线系统 C|O|S|M|O® 60mm busbar-system

当代配电系统基于母线技术。母线作为馈线，连接分支电路并可适应于各类配电盘和控制柜中所有的常用元器件。直接安装在母排上的各类元器件是最经济的电路连接方式。

金米勒低压熔断器隔离开关，母线式熔断器底座及适配器都可以用于母线系统。

*Contemporary power distribution is based on busbar technology. Busbars serve as feeders for connecting branch circuits and accommodate all components commonly used in power distribution and control panels. Electric connections are most economically established by direct mounting of the different devices on the busbars.*

*Among other devices, NH fuse-switches, NH fuse-bases for busbar mounting and adapters for other devices are used.*



## 目录

## Contents

<b>产品介绍</b>	<b>G-2</b>	<b><i>Introduction</i></b>	<b>G-2</b>
<b>母排支架与接线模块</b>	<b>G-4</b>	<b><i>Busbar support and connecting modules</i></b>	<b>G-4</b>
<b>低压高分断熔断器底座</b>	<b>G-7</b>	<b><i>NH fuse-bases</i></b>	<b>G-7</b>
附件	G-8	<i>Accessories</i>	G-8
<b>设备适配器</b>	<b>G-9</b>	<b><i>Device adapter</i></b>	<b>G-9</b>
附件	G-11	<i>Accessories</i>	G-11
<b>技术参数</b>	<b>G-12</b>	<b><i>Technical data</i></b>	<b>G-12</b>
<b>产品尺寸</b>	<b>G-14</b>	<b><i>Dimensions</i></b>	<b>G-14</b>

C|O|S|M|O®

C|O|S|M|O®

## C|O|S|M|O® – 60mm母线系统 C|O|S|M|O® – 60mm busbar-system

### 产品定义

COSMO系列产品应用于60mm母线系统。不同的接线方式和电缆进出线方式可实现不同的应用。基于母线的直接安装方式可确保用电设备的快速安装和可靠接触。

金米勒产品可适用于不同的母线宽度和母线厚度。其直接的安装方式避免了繁琐的接线过程。

### 应用领域

我们的COSMO产品主要用于3极和4极的60mm母线系统的开关柜。

安装断路器，电流接触器和电机启动组合开关也非常简单。

### 产品优势

产品具有高灵活性，9mm标准模数间距及简易的安装方式：插入—接线—完成。

### 载流单元

镀银触头保证接触系统的较低功耗，并且无需安装适配器。

载流单元的优化可减少设备运行中的温升。

### Product definition

The COSMO line of products has been developed as a system platform for mounting on and installation in 60mm busbar systems. Different connection types as well as bottom and top outgoing connections allow for an individual configuration. Direct connection to the busbars makes fast and reliable contacts.

Different busbar width and thicknesses are covered, direct mounting makes complex wiring obsolete.

### Field of application

Our COSMO products are preferably applied in switchboards having 60mm busbar systems, either 3-pole or 4-pole systems.

Application for simple mounting of circuit breakers, contactors and motor starter combinations is also possible.

### Product advantages

Great flexibility, standardized 9mm spacing and easy installation: Snap on – connect – ready.

### Current carrying parts

The silver plated contact system ensures low power dissipation, which is supported by adapterless mounting.

Current carrying parts optimized for their specific current rating guarantee avoiding excess temperature rise during operation.

#### **绝缘部件**

和其他金米勒的隔离开关一样，cosmo系统由不易断裂，耐高温材料制造，并具有很高的耐压和耐蠕变电流特性。

所有的塑料成分都是由高强度聚酯组成，具有抗断性，自熄阻燃，无卤素等特点。

#### **多样性和附件**

COSMO系统提供多样的底座，开关和接线模块，并有多种馈电单元。

附件有多种选择，额外的盖板盖罩可有效防止意外触摸。

#### ***Insulating parts***

*Like any other JEAN MÜLLER switchgear, break-resistant and temperature resistant polymeric materials are used. Tracking resistance and dielectric strength are assured as well.*

*All plastic parts have a high impact strength, are self extinguishing and halogen-free.*

#### ***Modifications and accessories***

*COSMO offers different fuse-bases, fuse switches and connection modules as well as various feeder elements to the busbar system.*

*Its accessories cover a broad field of applications. Additional protective covers and shrouds provide protection against unintentional access to live parts.*

## 母线支架和接线模块 *Busbar supports and connection modules*



### 产品优势 母线支架

- 由两个部件组成的母线支架可根据母排的不同宽度进行调节



### 母线盖板

- 卡轨式母线盖板用于保护三级和四级的母线系统
- 随时可拓展可拆卸, 无需测量和剪切, 提供额外的覆盖宽度



### 接线模块

- 接线模块连接母线与供电单元并提供接触保护
- 固定的集成端子提供了电流连接

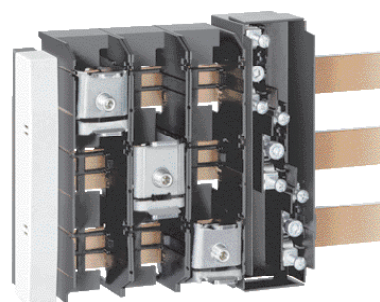

### *Convincing advantages*

#### *Busbar supports*

- *Two-piece busbar supports adjustable to different busbar width by means of integrated adjusting element*

#### *Busbar cover*

- *Clip-on busbar covers are used for the protection of 3-pole and 4-pole busbar systems*
- *They are extendable or detachable at anytime. In addition they offer variable covering widths without measuring and cutting*

#### *Connection modules*

- *Connection modules connect the busbars to power supply and protect against unintentional access to live parts*
- *Integrated robust clamps establish electrical contact*

**母线支架**  
*Busbar support*

产品描述 <i>Description</i>	包装 <i>PU</i>	型号 <i>Type</i>	订货号 <i>Article-No.</i>
单极/ <i>1-pole</i>	10	SST-60/1	G1410000
三极/ <i>3-pole</i>		SST-60/3	G1430001
四极/ <i>4-pole</i>		SST-60/4	G1440002
三极, 适用于标准安装板Striebl+John, 30x5mm <i>3-pole, for stand. mounting panel Striebl+John, 30x5mm</i>		SST-60/3-5	G1431006
三极, 适用于标准安装板Striebl+John, 30x10mm <i>3-pole, for stand. mounting panel Striebl+John, 30x10mm</i>		SST-60/3-10	G1431007

**带端子的母线支架**  
*Busbar support with terminal*

框型端子, 最大25mm <sup>2</sup> / <i>Frame terminal up to 25mm<sup>2</sup></i>	5	SST-60/3-A25	G1432017
插入式端子, 最大16mm <sup>2</sup> / <i>Plug-in terminal up to 16mm<sup>2</sup></i>		SST-60/3-A16	G1432018

**高度补偿**  
*Height compensation*

5mm	100	H5-SST-60	G8493010
-----	-----	-----------	----------

**侧盖板**  
*Lateral cover*

三极/ <i>3-pole</i>	10	A-SST-60/3	G8431001
四极/ <i>4-pole</i>		A-SST-60/4	G8441002

**母线盖板**  
*Busbar cover*

三极/ <i>3-pole</i>	50	SAD60/3	G8432006
四极/ <i>4-pole</i>		SAD60/4	G8442007

**母排保护罩**  
*Busbar cover*

单极, 适用于20mm宽母排/ <i>1-pole, for BB-width 20mm</i>	20	SAD/1/20	G8412047
单极, 适用于30mm宽母排/ <i>1-pole, for BB-width 30mm</i>		SAD/1/30	G8412048

**接线模块 250A***Connecting modules up to 250A*

产品描述 <i>Description</i>	包装 <i>PU</i>	型号 <i>Type</i>	订货号 <i>Article-No.</i>
三极/ <i>3-pole</i> 1,5mm <sup>2</sup> -70mm <sup>2</sup>	1	AM-60/250/3	G1540000
四极/ <i>4-pole</i> 1,5mm <sup>2</sup> -70mm <sup>2</sup>		AM-60/250/4	G1544007
三极/ <i>3-pole</i> , 16mm <sup>2</sup> -120mm <sup>2</sup> , 母排/ <i>busbar</i> 5mm		AM-60/250/3/120-5	G1543027
三极/ <i>3-pole</i> , 16mm <sup>2</sup> -120mm <sup>2</sup> , 母排/ <i>busbar</i> 10mm		AM-60/250/3/120-10	G1543028

**接线模块 630A***Connecting modules up to 630A*

三极/ <i>3-pole</i> , 70mm <sup>2</sup> -300mm <sup>2</sup> (AL, CU, 扇形及圆形电缆/ <i>Sector- and round cable</i> )	1	AM-60/630/3	G1563001
三极/ <i>3-pole</i> , 扁平电缆/ <i>flatstrip</i> 11x21x1(2x)		AM-60/630/F/3	G1563006

**导线端子 › 母排厚度 5mm***Conductor terminals › Busbar-thickness 5mm*

1,5mm <sup>2</sup> -16mm <sup>2</sup>	50	LAK5/16	G8510000
4mm <sup>2</sup> -35mm <sup>2</sup>		LAK5/35	G8510001
10mm <sup>2</sup> -50mm <sup>2</sup>	15	LAK5/50	G8510002
16mm <sup>2</sup> -70mm <sup>2</sup>		LAK5/70	G8510003
16mm <sup>2</sup> -120mm <sup>2</sup>		LAK5/120	G8510004
50mm <sup>2</sup> -185mm <sup>2</sup>		LAK5/185	G8510005

**导线端子 › 母排厚度 10mm***Conductor terminals › Busbar-thickness 10mm*

1,5mm <sup>2</sup> -16mm <sup>2</sup>	50	LAK10/16	G8510006
4mm <sup>2</sup> -35mm <sup>2</sup>		LAK10/35	G8510007
10mm <sup>2</sup> -50mm <sup>2</sup>	15	LAK10/50	G8510008
16mm <sup>2</sup> -70mm <sup>2</sup>		LAK10/70	G8510009
16mm <sup>2</sup> -120mm <sup>2</sup>		LAK10/120	G8510010
50mm <sup>2</sup> -185mm <sup>2</sup>		LAK10/185	G8510011

**扁平端子***Plate terminal*

母排厚度/ <i>BB-width</i> 30mm, 端子大小/ <i>Terminal space</i> 34mm x 10mm	3	PK30/34x10	G8530038
---	---	------------	----------

**系统盖罩 › 高 195mm***System cover › Height 195mm*

宽/ <i>Width</i> 144mm	1	SADH-60/144	G8434011
宽/ <i>Width</i> 84mm		SADH-60/84	G8434050

**母排连接器***Busbar connector*

长度/ <i>Length</i> 101mm-105mm	3	SV20x5-30x10	G8416022
-------------------------------	---	--------------	----------



## 低压高分断熔断器底座 NH fuse-bases



### 产品优势

#### 低压高分断熔断器底座

- 多种端子技术，如菱形端子，V型端子，框式端子，螺栓端子
- 保护盖罩卡轨式安装和便捷的拆卸方式
- 可选配透明手柄盖罩
- 多种电缆连接方式
- 上下出线

### Convincing advantages

#### NH fuse-base

- Various methods of termination, such as terminal clamps, V-terminal clamps, elevator type or screw type terminals
- Protective covers for clip-on mounting and easy detaching
- Transparent gripping-lug covers available
- Different types cable connection
- Outgoing cable top or bottom

低压高分断熔断器底座 › 尺寸 00 › 40mm, 50mm或60mm母线系统 › 旋锁安装技术  
NH-fuse-bases › Size 00 › 40mm, 50mm or 60mm busbar systems › Twistlock assembly technique

接线方式 Terminal version	线径 [mm <sup>2</sup> ]	额定电流 [A]	包装 PU	型号 Type	订货号 Article-No.
扁平端子 M8 Flat terminal M8	1 x 10-95	160	1	GU00-3/60	G5981000
框型端子 F57 Elevator clamp F57	1,5-70			GU00-3/60/F57	G5987001

低压高分断熔断器底座 › 尺寸 1 › 60mm母线系统 › 免打孔挂钩安装技术  
NH-fuse-bases › Size 1 › 60mm busbar systems › Drillfree clamping technique

接线方式 Terminal version	进线方式 Power feed	线径 [mm <sup>2</sup> ]	额定电流 [A]	包装 PU	型号 Type	订货号 Article-No.
扁平端子 M10/Flat terminal M10	下/Bottom	25-150mm <sup>2</sup>	250	1	GU1-3/60/AU	U1401005
扁平端子 M10/Flat terminal M10	上/Top				GU1-3/60/AO	U1410006

低压高分断熔断器底座 › 尺寸 2 › 60mm母线系统 › 免打孔挂钩安装技术  
NH-fuse-bases › Size 2 › 60mm busbar systems › Drillfree clamping technique

接线方式 Terminal version	进线方式 Power feed	线径 [mm <sup>2</sup> ]	额定电流 [A]	包装 PU	型号 Type	订货号 Article-No.
扁平端子 M10/Flat terminal M10	下/Bottom	25-240mm <sup>2</sup>	400	1	GU2-3/60/AU	U2401030
扁平端子 M10/Flat terminal M10	上/Top				GU2-3/60/AO	U2410029

## 附件/Accessories

	产品描述 <i>Description</i>	尺寸 <i>Size</i>	包装 <i>PU</i>	型号 <i>Type.</i>	订货号 <i>Article-No.</i>	页码 <i>Page</i>
<b>盖罩, 三极, 母线安装/Protective cover 3-pole, busbar mounting</b>						
	顶部, 模块尺寸 195mm <i>Top side, system measure 195mm</i>	00	1	GO-LTL00-3/195	T8590462	-
	顶部, 模块尺寸 230mm <i>Top side, system measure 230mm</i>	00		GOV-LTL00-3/230	T8590459	-
	顶部/ <i>Top side</i>	1		GOV-LTL1-3	T8190226	-
	顶部/ <i>Top side</i>	2		GOV-LTL2-3	T8290566	-
	底部, 模块尺寸 195mm <i>Bottom side, system measure 195mm</i>	00		GU-LTL00-3/195	T8590463	-
	底部, 模块尺寸 230mm <i>Bottom side, system measure 230mm</i>	00		GUV-LTL00-3/230	T8590460	-
	底部/ <i>Bottom side</i>	1		GUV-LTL1-3	T8190227	-
	底部/ <i>Bottom side</i>	2		GUV-LTL2-3	T8290567	-
<b>低压高分断熔断器底座保护面罩/Handle protection for NH fuse-base</b>						
	Typ H-U00	00	3	A-GU00-3	G8900000	-

## 设备适配器 Device adapter



### 产品优势

#### 接触系统

- 接触系统使用弹簧装配, 提供安全的母排连接



#### 母线系统

- 快速安装于12-30mm母排宽度的三级、四级母线系统中
- 适用于5mm和10mm母排厚度 (可通过折断塑料间隔片, 使原来适用5mm母排厚度的挂钩适用于10mm母排厚度)



#### 安装

- 预接电缆用于直接连接接触器或断路器
- 可直接安装符合DIN导轨的标准产品
- 适用于不同品牌和类型的微型断路器



#### 通用型3极/4极断路器适配器

- 顶部及底部均可使用接线端子
- 不使用时可以加盖防护罩
- 低功耗设计
- 专业认可的SK挂钩头
- 适用于大部分常用的3极或4极塑壳断路器

### Convincing advantages

#### Contact system

- *The contact system is spring loaded for reliable busbar connection*

#### Busbar system

- *Quick-latch mounting on 3-pole and 4-pole busbar systems*
- *One device fits 5mm and 10mm thick busbars (supplied to fit 5mm bars, may be altered on site to fit 10mm bars by breaking-off plastic spacer)*

#### Installation

- *Pre-assembled cables for direct connection of contactors and circuitbreakers on the adapter*
- *Free positioning of the DIN rail on the adapter*
- *Suitable for all major types MCCBs and motor starter combinations of leading manufacturers*

#### Universal 3-Pole/4-Pole CB Adaptor

- *Cable terminal top / bottom possible*
- *Shrouding if not in use*
- *Low power loss design*
- *Approved busbar terminal clamps (SK type clamps)*
- *Suitable for the most common std. 3/4pol MCCB's*

C|O|S|M|O®

C|O|S|M|O®

1 个安装导轨 › 三极  
1 mounting rail › 3-pole

额定电流 Rated current [A]	宽 Width [mm]	线径 Cross section	包装 PU	型号 Type	订货号 Article-No.
25	45	AWG12	1	GA-60/25/45/1	G1821008
32	54	AWG10		GA-60/32/54/1	G1821011
32	63			GA-60/32/63/1	G1821013
32	72			GA-60/32/72/1	G1821014
63	54	AWG8		GA-60/63/54/1	G1831018
63	63			GA-60/63/63/1	G1831020
63	72			GA-60/63/72/1	G1831021

2 个安装导轨 › 三极  
2 mounting rails › 3-pole

25	45	AWG12	1	GA-60/25/45/2	G1822009
32	54	AWG10		GA-60/32/54/2	G1822012
32	81			GA-60/32/81/2	G1822016
32	108			GA-60/32/108/2	G1822010
63	54	AWG8		GA-60/63/54/2	G1832019
63	81			GA-60/63/81/2	G1832022
63	108			GA-60/63/108/2	G1832017

螺纹安装 › 三极  
Screw mounting › 3-pole

额定电流 Rated current [A]	断路器型号 Unit type	包装 PU	型号 Type	订货号 Article-No.
160	GE-FD-Frame	1	GA-60/160/3/FD	G1847023
250	GE-FE-Frame		GA-60/250/3/FE	G1867025
250	Moeller NZM 7		GA-60/250/3/NZM7	G1867029
100	Schneider Electric		GA-60/100/3/NS100/160	G1847031
250	Schneider Electric		GA-60/250/3/NS250	G1867033
250	通用/Universal		GA-60/250/3/M4/AU <sup>1)</sup>	G1867162
250	通用/Universal		GA-60/250/3/M5/AU <sup>1)</sup>	G1867160
630	通用/Universal		GA-60/630/3/AU <sup>1)</sup>	G1897164

螺纹安装 › 四极  
Screw mounting › 4-pole

160	GE-FD-Frame	1	GA-60/160/4/FD	G1847024
250	GE-FE-Frame		GA-60/250/4/FE	G1867026
250	Moeller NZM 74		GA-60/250/4/NZM74	G1867030
100	Schneider Electric		GA-60/100/4/NS100/160	G1847032
250	Schneider Electric		GA-60/250/4/NS250	G1867034
630	通用/Universal		GA-60/630/4/AU <sup>1)</sup>	G1897178

1) 如需选用通用款适配器, 请与我们联系/ if you need universal adaptor for circuit breaker, please contact with us

## 附件/Accessories

	产品描述/Description	包装 PU	型号 Type	订货号 Article-No.	页码 Page
<b>导轨/Mounting rail</b>					
	宽/Width 45mm	10	TS-GA-45-7,5	G8440000	-
	宽/Width 54mm		TS-GA-54-7,5	G8440001	-
	宽/Width 63mm		TS-GA-63-7,5	G8440002	-
	宽/Width 72mm		TS-GA-72-7,5	G8440003	-
	宽/Width 81mm		TS-GA-81-7,5	G8440004	-
	宽/Width 90mm		TS-GA-90-7,5	G8440013	-
<b>连接件/Connecting piece</b>					
	用于连接两个适配器 For connecting of 2 adapters	100	VS-GA	G8820005	-
<b>宽度补偿板/Width compensation</b>					
	宽/Width 9mm	10	B9-GA	G8870006	-
<b>可调节安装导轨/Mobile mounting rail</b>					
	宽/Width 45mm	5	MT-GA-45	G8850007	-
	宽/Width 54mm		MT-GA-54	G8850008	-
	宽/Width 63mm		MT-GA-63	G8850014	-
<b>适配器模块/Adapter module</b>					
	宽/Width 45mm	1	AM-GA-45-5	G8860010	-
	宽/Width 54mm		AM-GA-54-5	G8860012	-
<b>补偿件/Compensation piece</b>					
	适用于 5-10mm 厚度的母排 For busbar thickness 5 to 10mm	20	HA5	G8790005	-

低压高分断熔断器底座技术参数 (根据标准 EN 60269-1, EN 60269-2-2)  
 Technical data of NH fuse bases (in according to EN 60269-1, EN 60269-2-2)

型号/Type				GU00-3	GU1-3	GU2-3			
电气参数 Electrical characteristics	额定工作电压 Rated operating voltage	U <sub>e</sub>	V	AC690	AC690	AC690			
	额定工作电流 Rated operating current	I <sub>e</sub>	A	160	250	400			
	使用熔断器时约定发热电流 Conv. thermal current with fuse links	I <sub>th</sub>	A	160	250	400			
	使用隔离刀片时约定发热电流 Conv. thermal current with solid links	I <sub>th</sub>	A	210	325	520			
	额定频率 Rated frequency	-	Hz	40-60	40-60	40-60			
熔断器 Fuse links	尺寸, 根据标准 DIN 43620 Size in according to DIN 43620	-	-	00	1	2			
	最大额定电流 (gI/gG) Max. rated current (gI/gG)	I <sub>n</sub>	A	160	250	400			
	最大允许功耗 (无熔断器时) Max permissible power dissipation (without fuse)	P <sub>v</sub>	W	12	23	45			
机械参数 Mechanical parameters	母排间距 (仅三相) Busbar spacing (only 3-pole)	-	mm	40/50/60	60	60			
电缆连接 Cable connection	扁平端子 Flat terminal	螺栓直径 Bolt diameter	-	-	M8	M10	M10		
		电缆线径/Cable lug (DIN 46235)	-	mm <sup>2</sup>	1 x 10-95 (max. 25mm breit/width)	25-150	25-240		
		矩形母排 Flat bar	-	mm	20 x 10	30 x 10	30x10		
		扭矩 Tightening torque	M <sub>a</sub>	Nm	12-15	30-35	30-35		
	端子 Clamp	电缆线径 Clamping range	-	mm <sup>2</sup>	S00	1,5-70	S1	S2	25-240
		扭矩 Tightening torque	M <sub>a</sub>	Nm		2,6			9,5
		电缆线径 Clamping range	-	mm <sup>2</sup>	P00-70	10-70	P1	P2	120-240
		扭矩 Tightening torque	M <sub>a</sub>	Nm		2,6			4,5
		电缆线径 Clamping range	-	mm <sup>2</sup>	F57	1,5-70	P12	P22	1,5-70
		扭矩 Tightening torque	M <sub>a</sub>	Nm		2,6			40
		电缆线径 Clamping range	-	mm <sup>2</sup>	-	-	K2G	K2G	35-185
		扭矩 Tightening torque	M <sub>a</sub>	Nm	-	40			40

**低压高分断熔断器底座技术参数 (根据标准 EN 60269-1, EN 60269-2-2)**  
*Technical data of NH fuse bases (in according to EN 60269-1, EN 60269-2-2)*

型号/Type				GU00-3	GU1-3	GU2-3	
防护等级 <i>Degree of protection</i>	前侧 <i>Frontside</i>	工作状态 <i>Operating state</i>	-	-	IP00	IP00	IP00
工作条件 <i>Operating conditions</i>	环境温度 <sup>1)</sup> / <i>Ambient temperature<sup>1)</sup></i>		T <sub>u</sub>	°C	-25 到/ <i>up to</i> 55		
	额定工作方式/ <i>Rated operating mode</i>		-	-	连续工作/ <i>Uninterrupted duty</i>		
	安装位置/ <i>Mounting position</i>		-	-	垂直, 水平/ <i>Vertical, horizontal</i>		
	海拔/ <i>Altitude</i>		-	m	高达/ <i>Up to</i> 2000		
	污染等级/ <i>Pollution degree</i>		-	-	3		
	过压等级/ <i>Overvoltage categorie</i>		-	-	III		

1) 35°C 正常使用/*Normal temperature*, 55°C 降容使用/*with reduced current*

产品尺寸/*Dimensions*

型号/Type	订货号/Article-No.	页码/Page
SST-60/1	G1410000	G-5

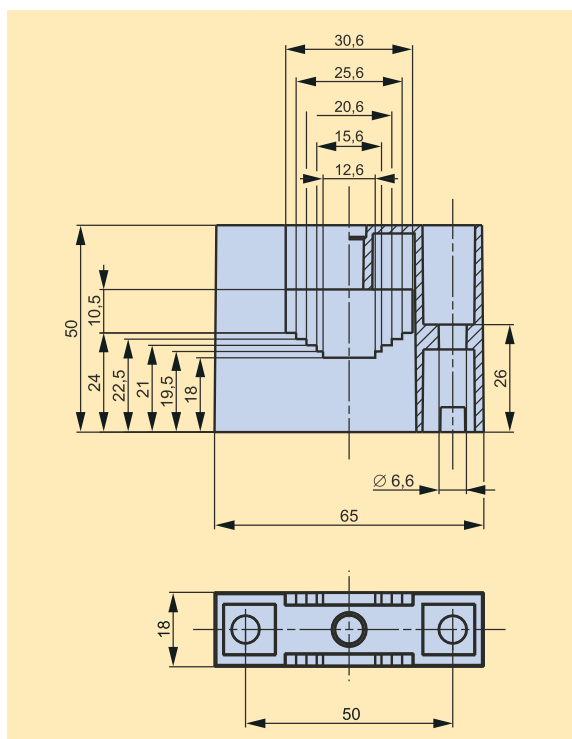

型号/Type	订货号/Article-No.	页码/Page
SST-60/3	G1430001	G-5

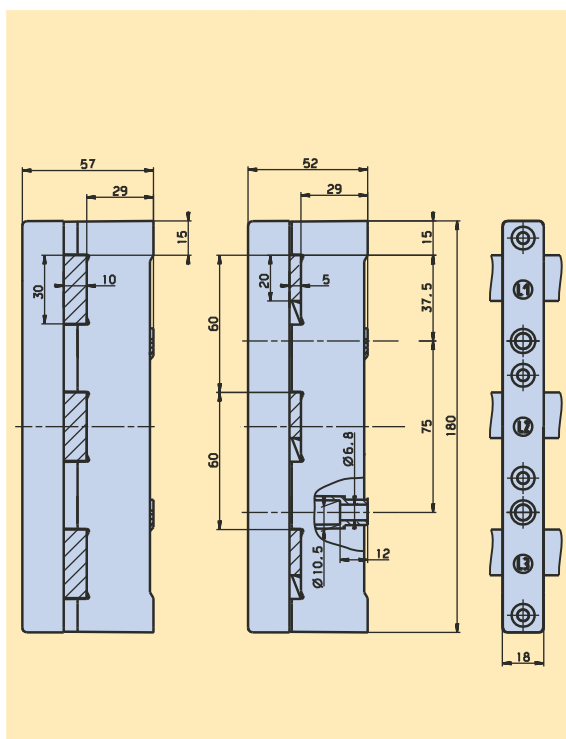

型号/Type	订货号/Article-No.	页码/Page
SST-60/3/3-5	G1430006	G-5

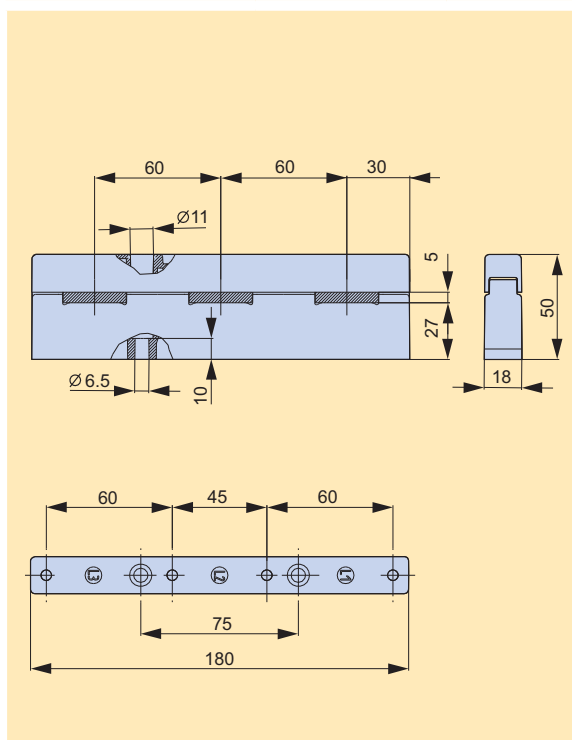

型号/Type	订货号/Article-No.	页码/Page
SST-60/3/3-10	G1430007	G-5

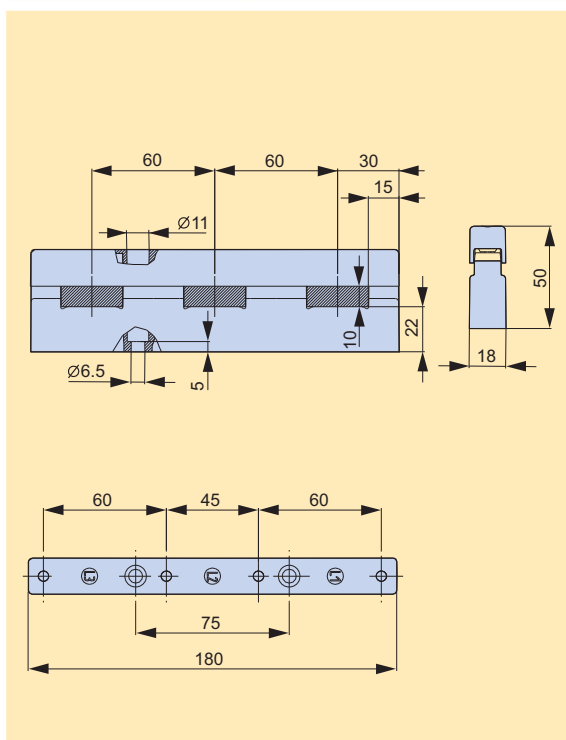



型号/Type	订货号/Article-No.	页码/Page
SST-60/4	G1440002	G-5

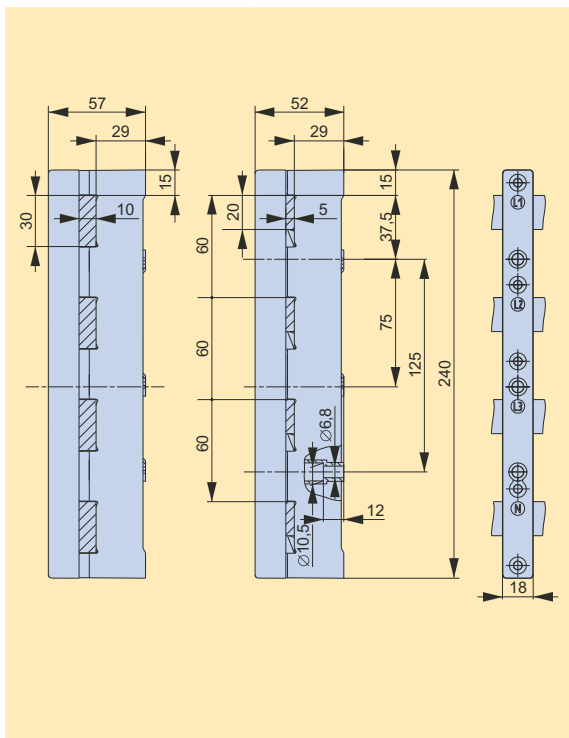

型号/Type	订货号/Article-No.	页码/Page
SST-60/3-A25	G1432017	G-5
SST-60/3-A16	G1432018	G-5

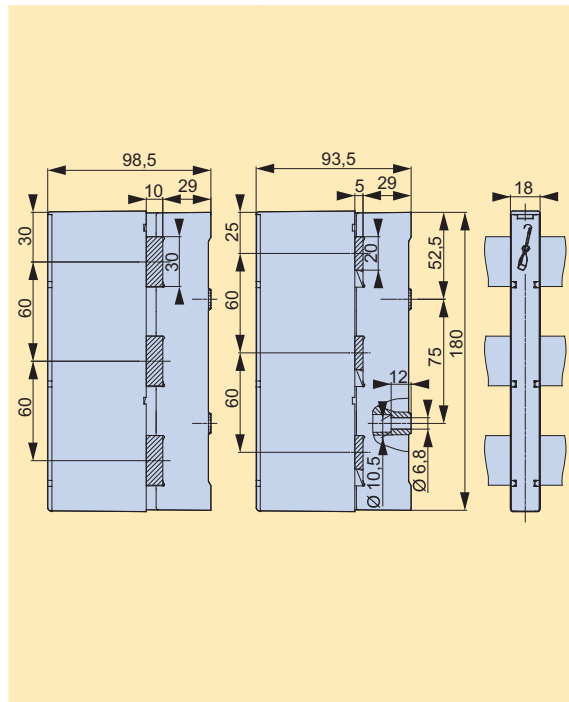

型号/Type	订货号/Article-No.	页码/Page
A-SST-60/3	G8431001	G-5

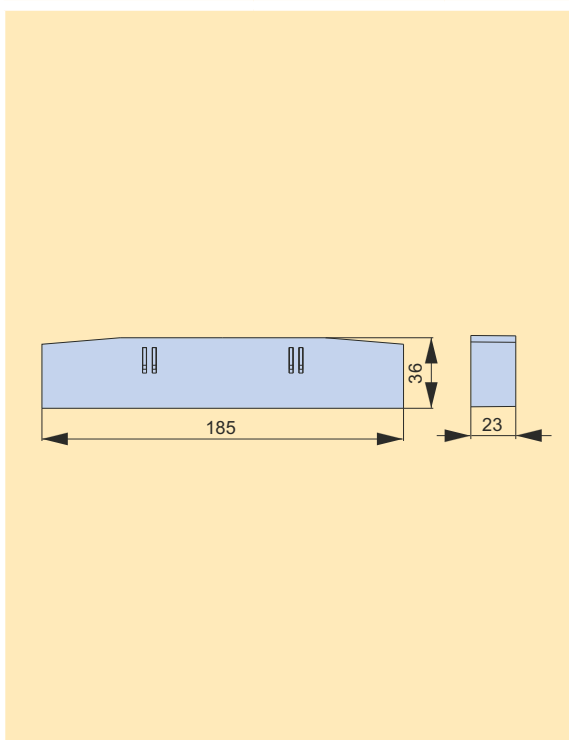

型号/Type	订货号/Article-No.	页码/Page
A-SST-60/3-A	G8431046	G-5

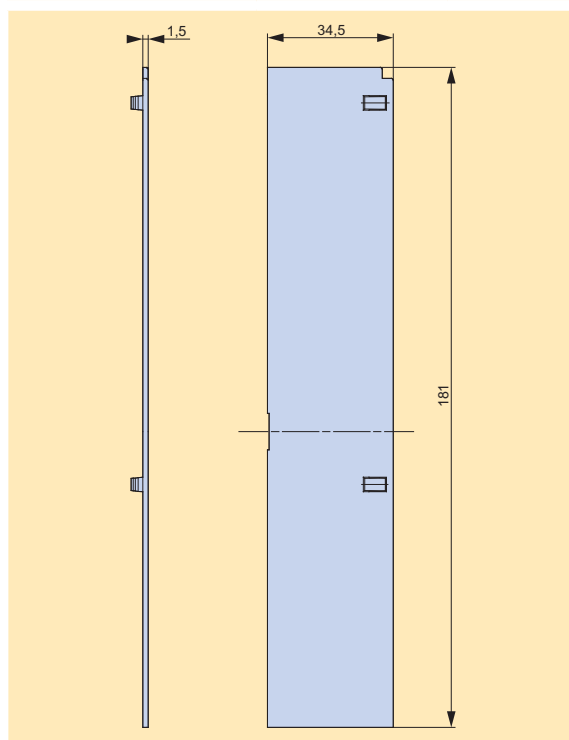

# C/O/S/M/O®

## C/O/S/M/O®

型号/Type	订货号/Article-No.	页码/Page	型号/Type	订货号/Article-No.	页码/Page
SAD60/3	G8432006	G-5	SAD60/4	G8432007	G-5

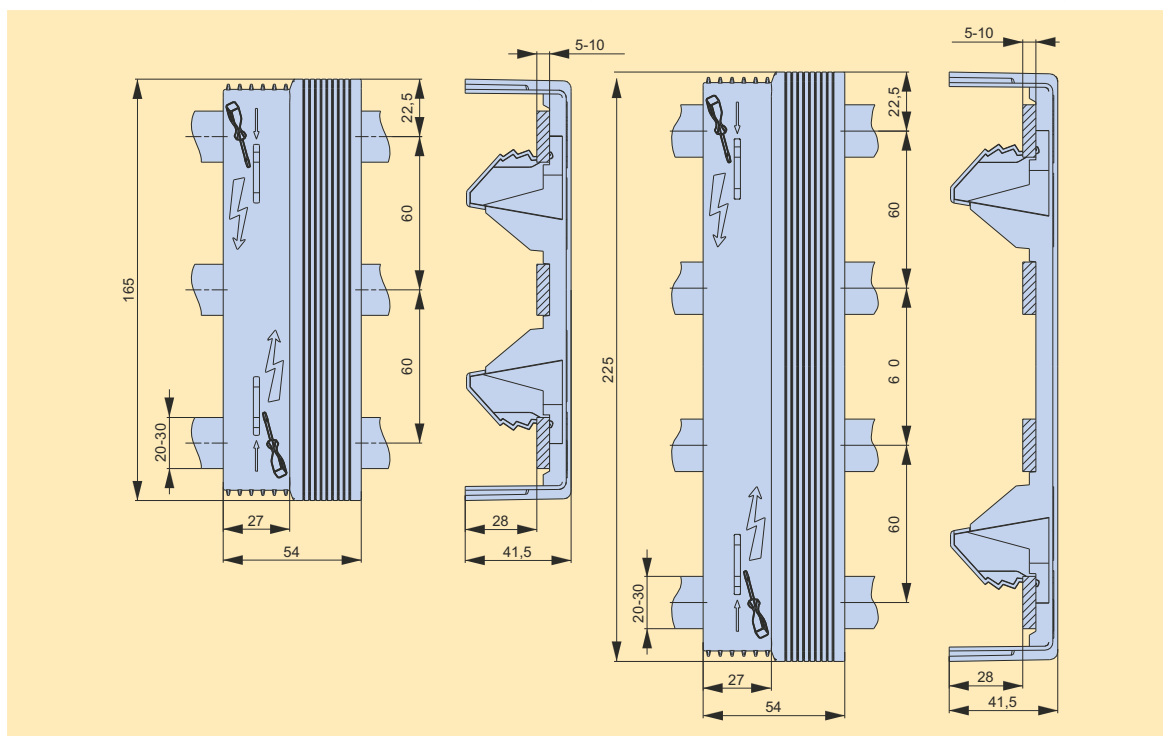

型号/Type	订货号/Article-No.	页码/Page
A-SST-60/4	G8441002	G-5

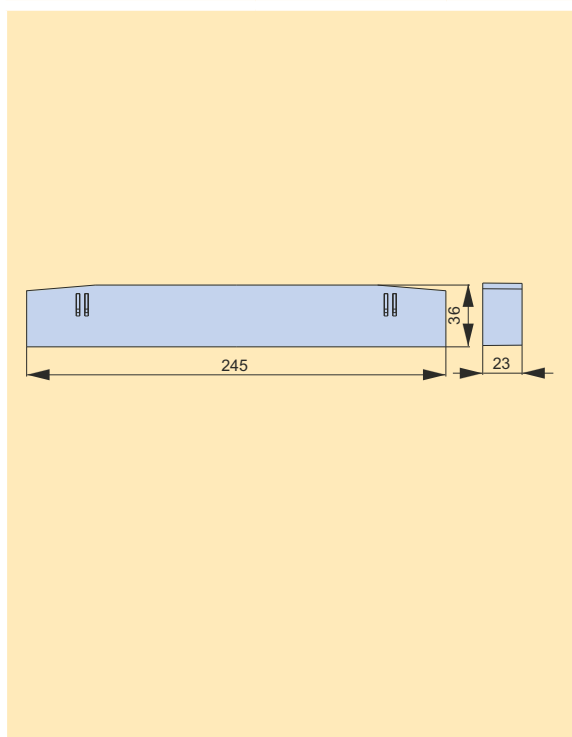

型号/Type	订货号/Article-No.	页码/Page
AM-60/250/3	G1540000	G-6

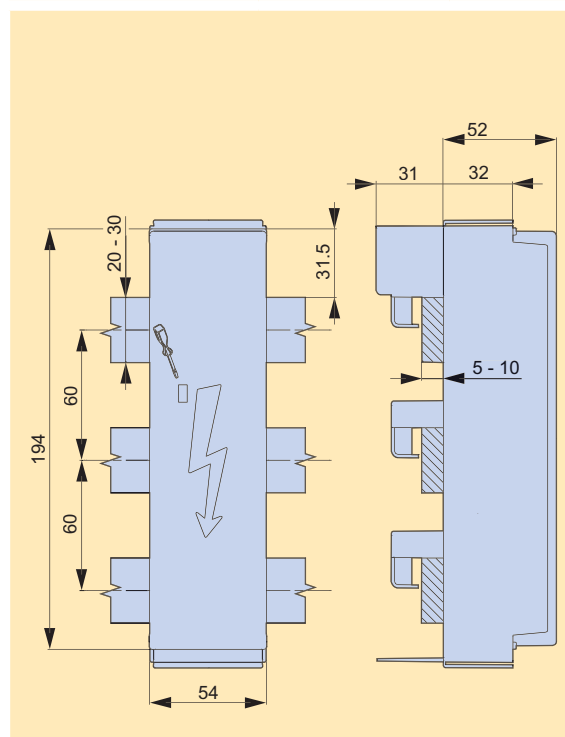

型号/Type	订货号/Article-No.	页码/Page
AM-60/630/3	G1563001	G-6
AM-60/630/F/3	D1563006	G-6

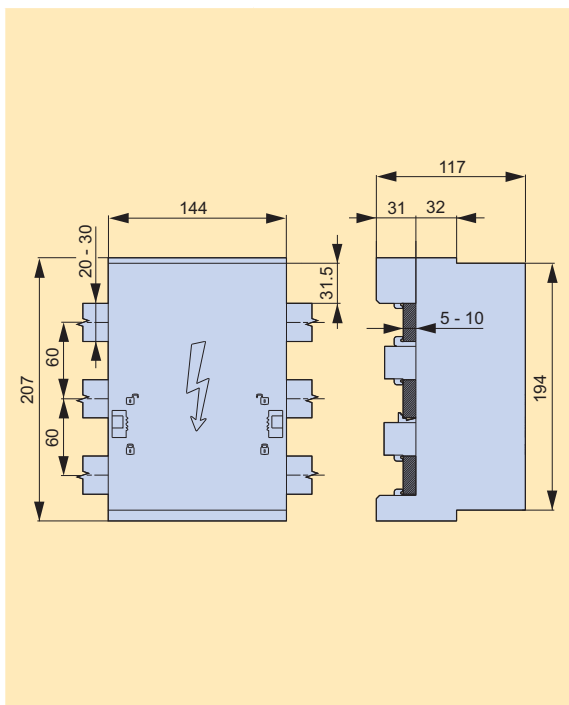

型号/Type	订货号/Article-No.	页码/Page
AM-60/250/4	G1544007	G-6

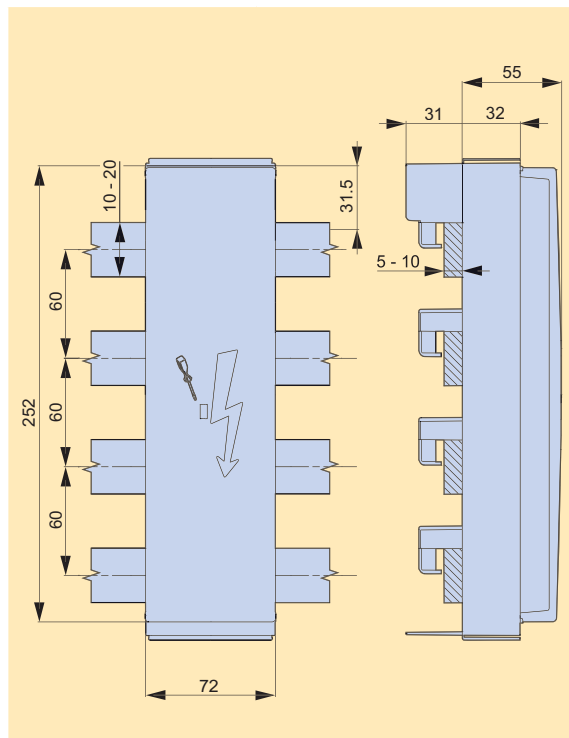

型号/Type	订货号/Article-No.	页码/Page
SADH-60/144	G8434011	G-6

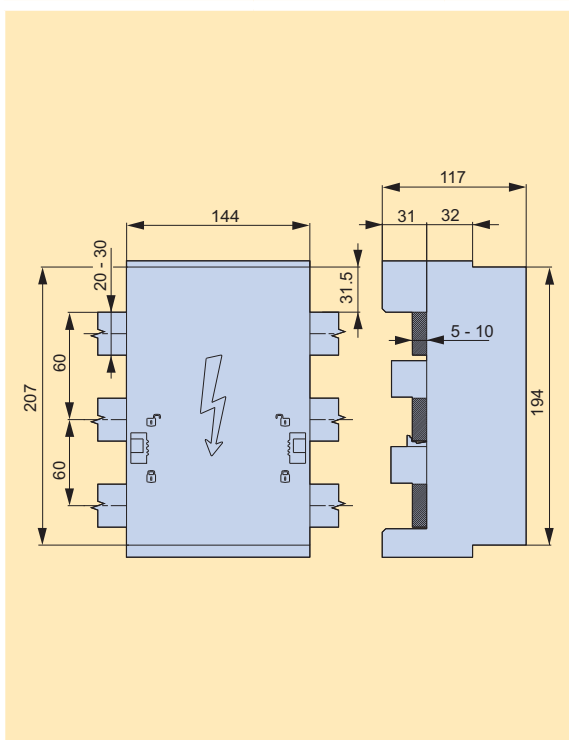

型号/Type	订货号/Article-No.	页码/Page
SV20X5-30X10	G8416022	G-6

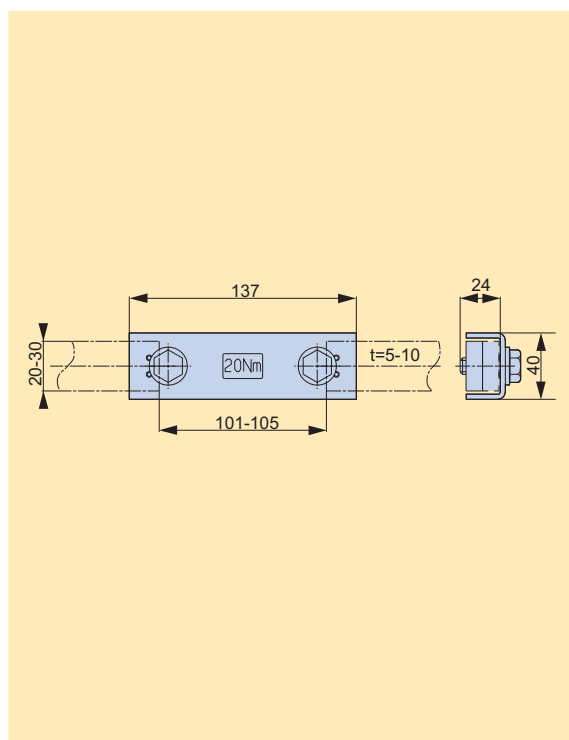

# C|O|S|M|O®

## C|O|S|M|O®

型号/Type	订货号/Article-No.	页码/Page	型号/Type	订货号/Article-No.	页码/Page
GU00-3/60	G5981000	G-8	GU00-3/60/F57	G5987001	G-8

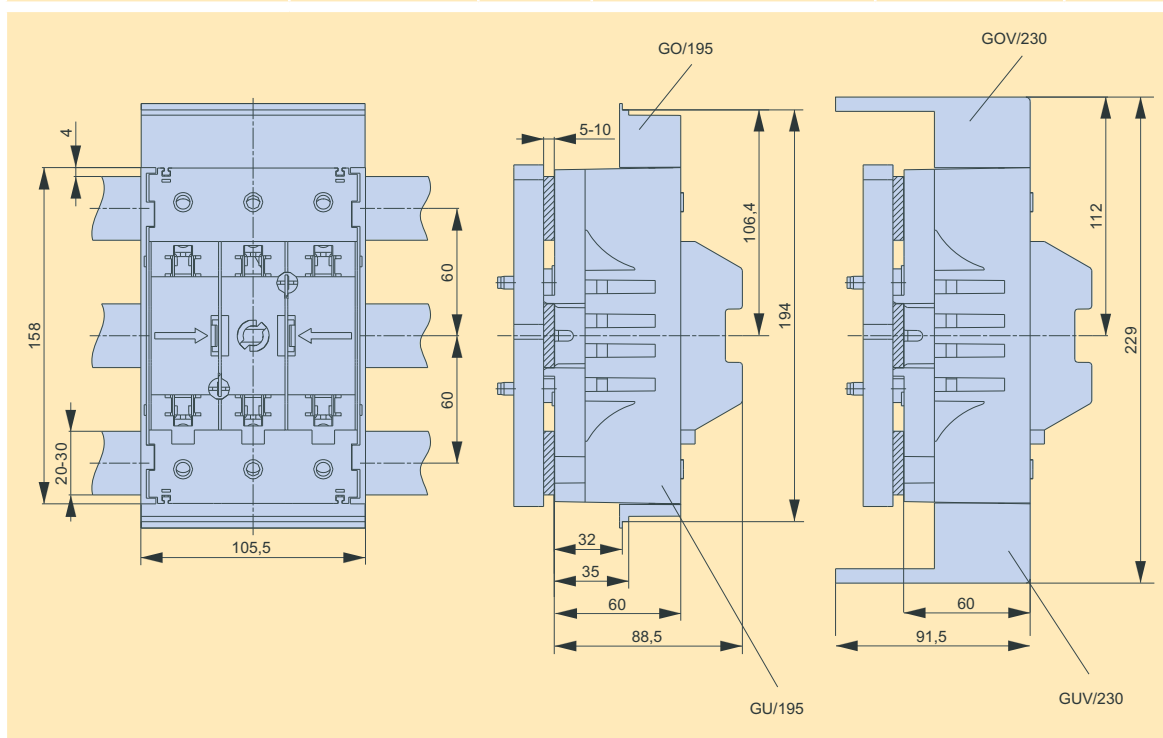

型号/Type	订货号/Article-No.	页码/Page	型号/Type	订货号/Article-No.	页码/Page
GU1-3/60/AU	U1401005	G-8	GU2-3/60/AU	U2401030	G-8

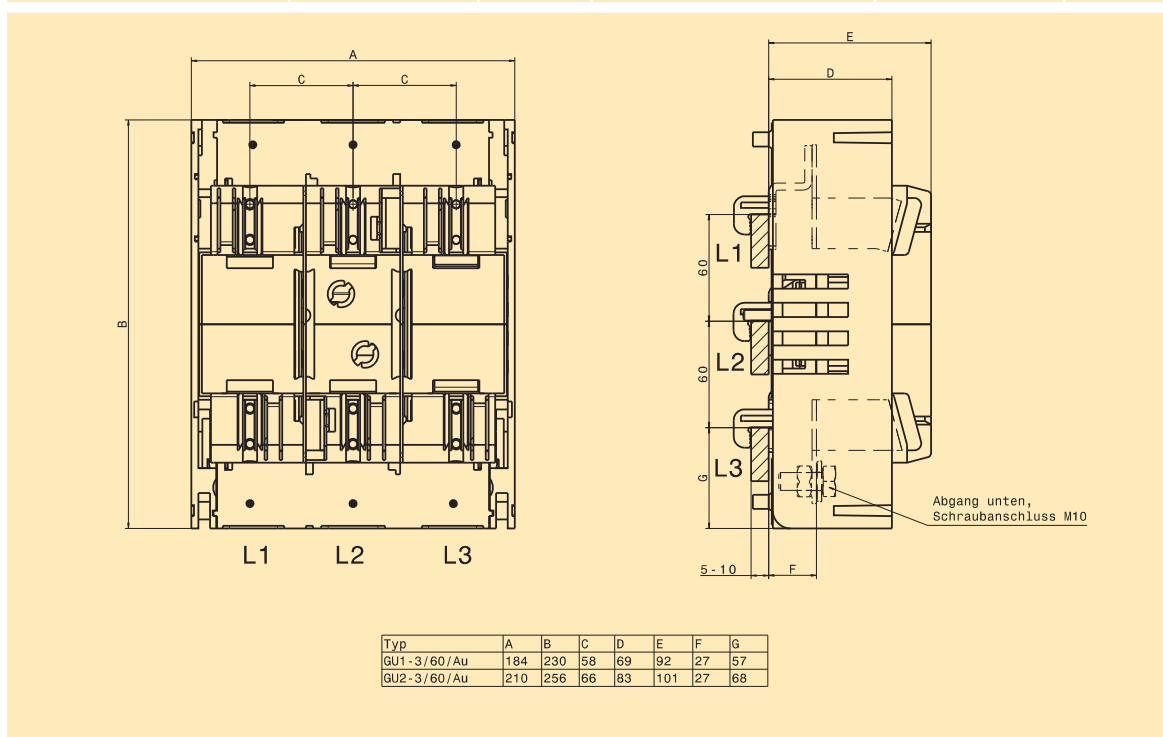

Typ	A	B	C	D	E	F	G
GU1-3/60/AU	184	230	58	69	92	27	57
GU2-3/60/AU	210	256	66	83	101	27	68

型号/Type	订货号/Article-No.	页码/Page
GA-60...	G18...	G-10

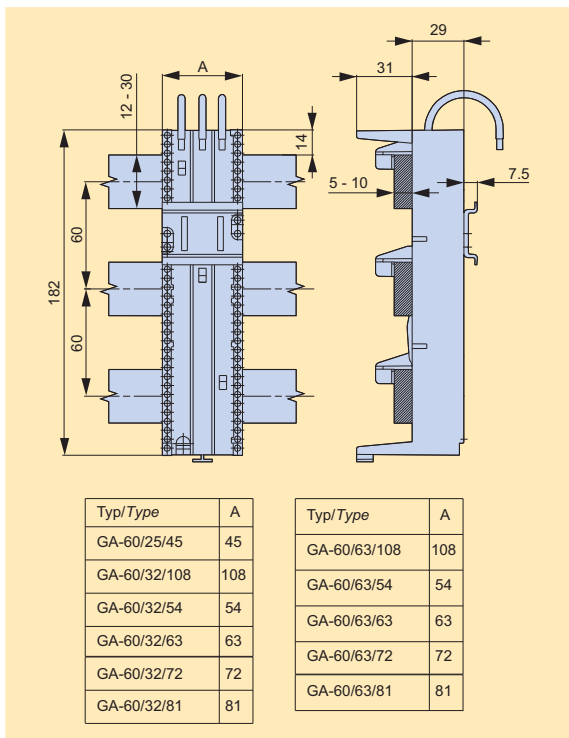

型号/Type	订货号/Article-No.	页码/Page
GA-60/160/3/FD	G1847023	G-10

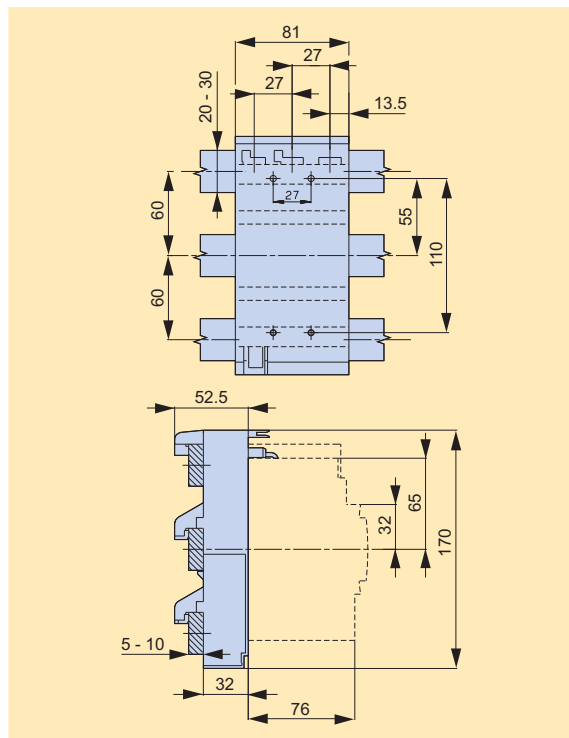

型号/Type	订货号/Article-No.	页码/Page
GA-60/160/4/FD	G1847024	G-10

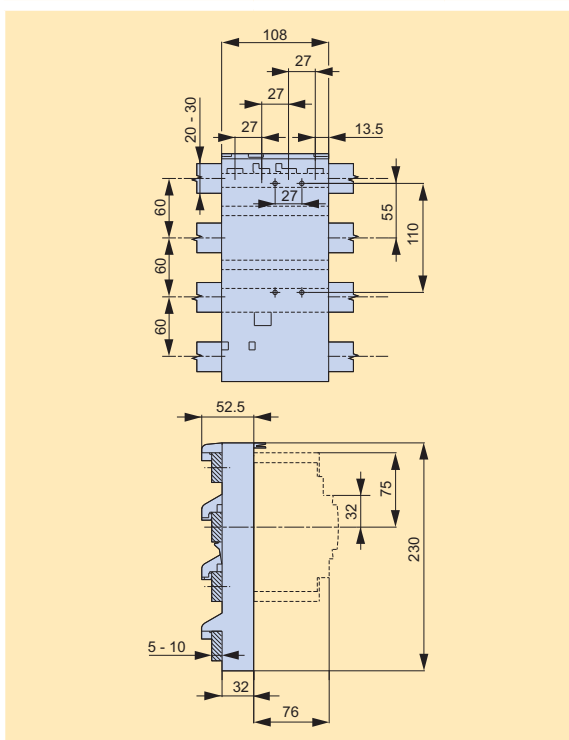

型号/Type	订货号/Article-No.	页码/Page
GA-60/250/3/FE	G1867025	G-10

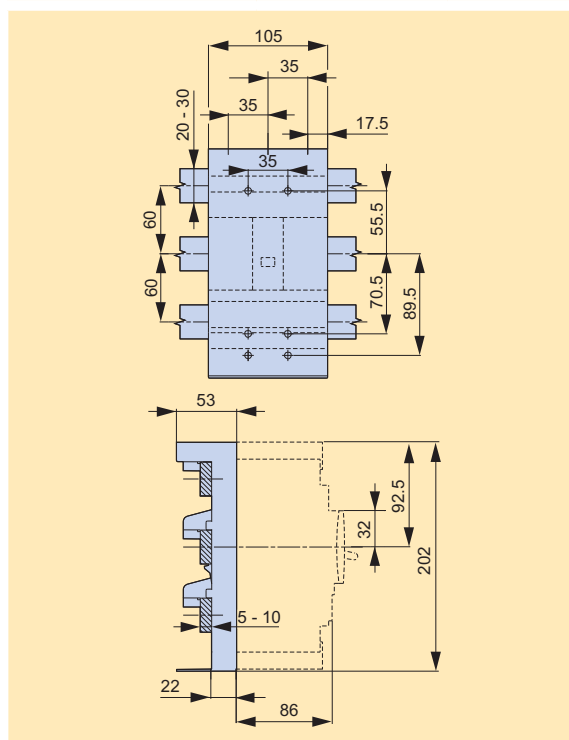

型号/Type	订货号/Article-No.	页码/Page	型号/Type	订货号/Article-No.	页码/Page
GA-60/250/3/M4/AU	G1867162	G-10	A-60/250/3/M5/AU	G1867160	G-10

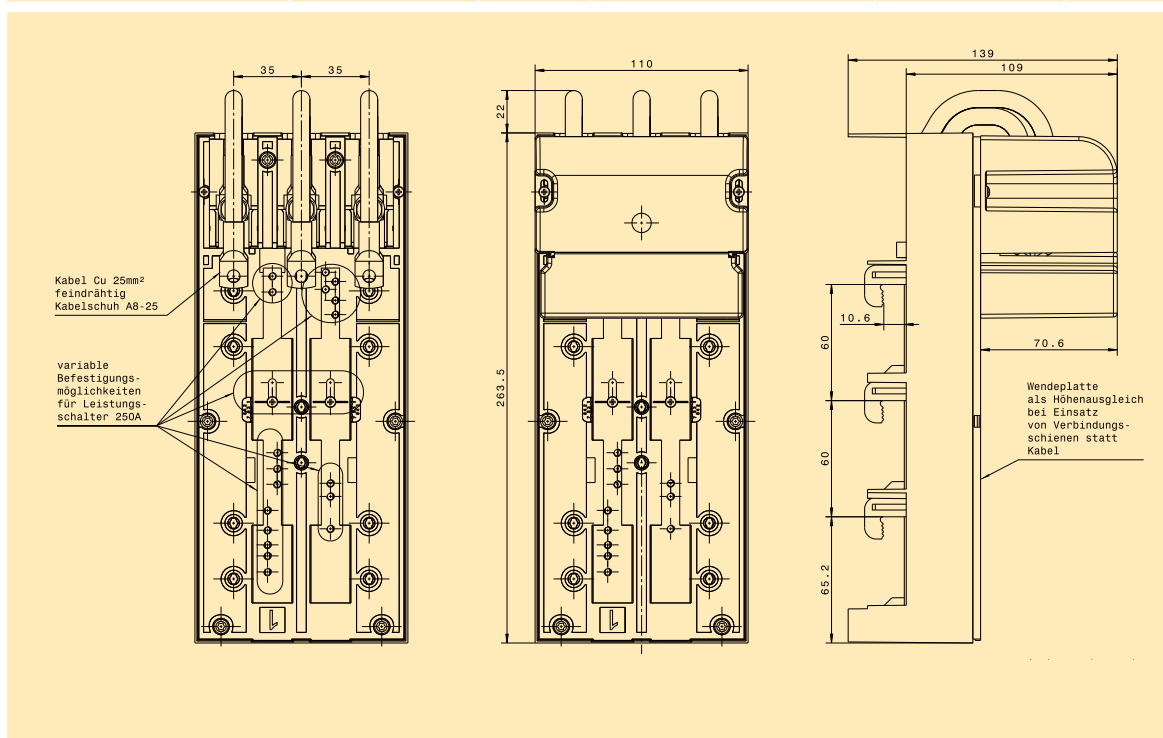

型号/Type	订货号/Article-No.	页码/Page	型号/Type	订货号/Article-No.	页码/Page
GA-60/630/3/AU	G1897164	G-10			

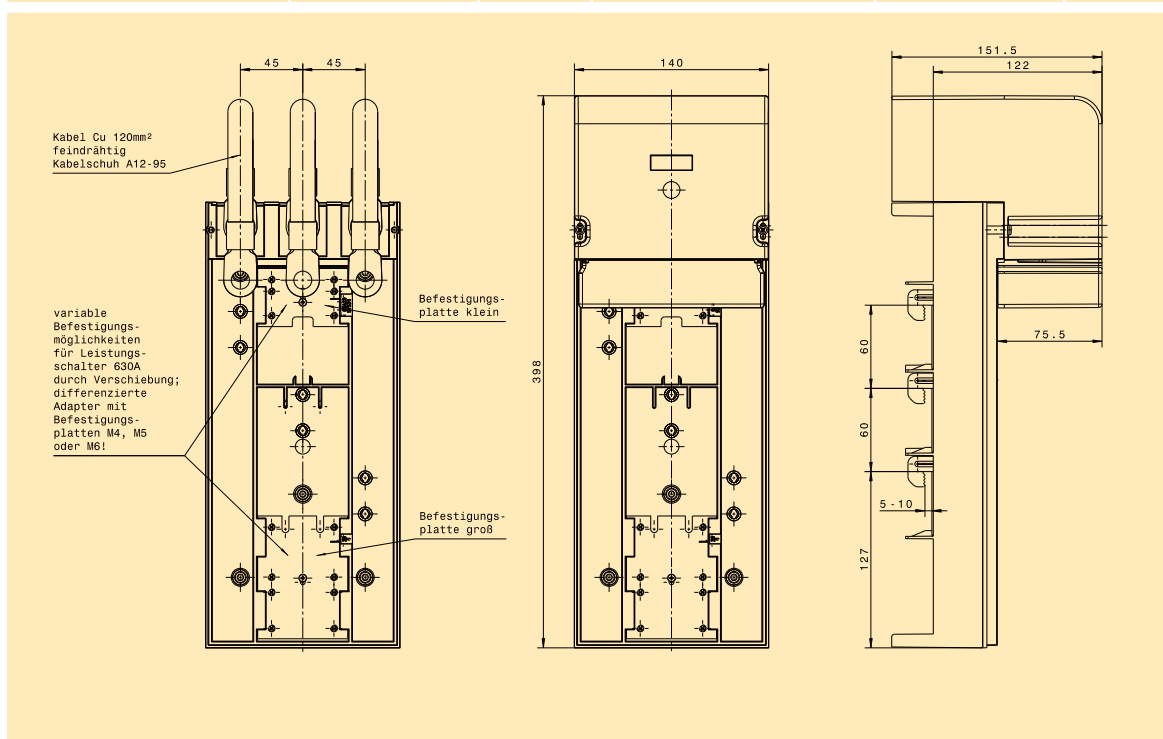

型号/Type	订货号/Article-No.	页码/Page	型号/Type	订货号/Article-No.	页码/Page
GA-60/630/4/AU	G1897178	G-10			

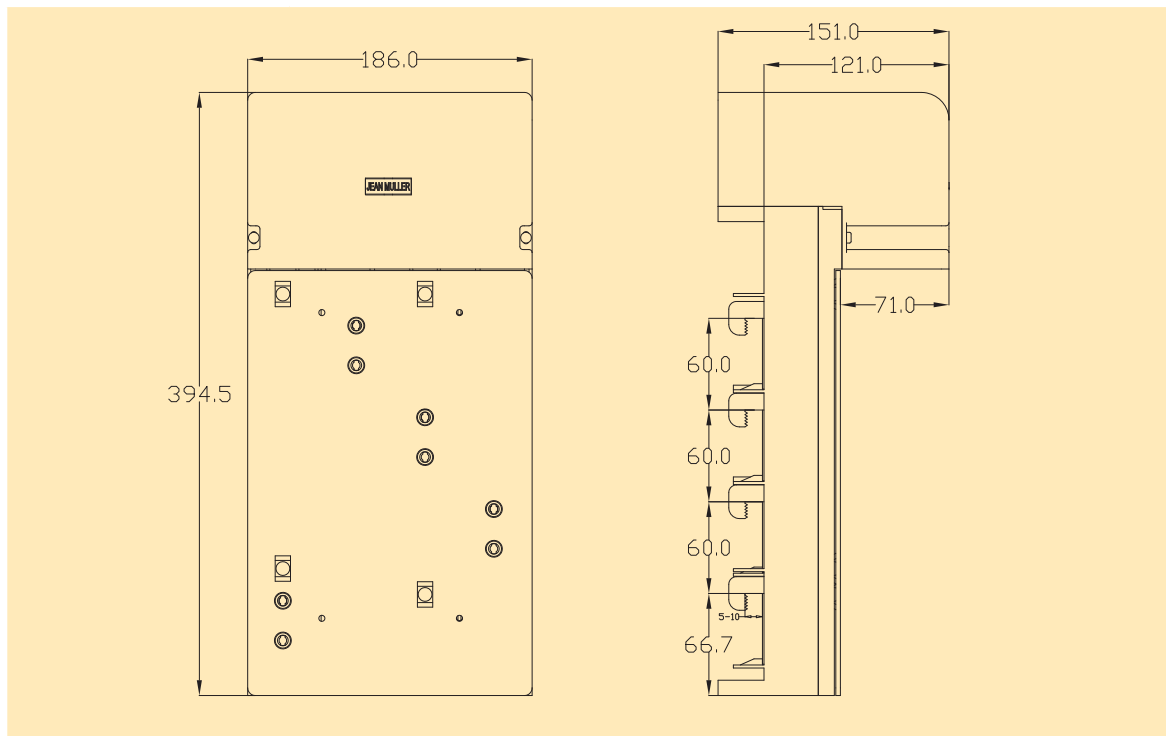

### 金米勒电气(上海)有限公司

上海外高桥保税区华申路80号5号楼2楼

电话: +86 21 5866 5980

传真: +86 21 5866 5981

http://www.jeanmueller.cn

e-mail: info@jeanmueller.cn

### 金米勒电气设备(天津)有限公司

天津市北辰科技园区高新大道76号

电话: +86 22 8698 6290

传真: +86 22 8698 6291

### 昆山办公室

江苏省昆山市古城中路78号欧洲工业园区J2

电话: +86 512 36906667

传真: +86 512 36906665

### 北京办事处

北京市石景山路22号万商大厦1519室

电话: +86 10 6865 7349

传真: +86 10 6865 7249 x 802

### 深圳办事处

深圳市福田区彩田路3069号星河世纪大厦C2

栋1302房

电话: +86 755 8256 1136

传真: +86 755 8256 1139

## 其他产品 / Further products

### 熔断器

低压高分断熔断器

高压高分断熔断器



### 配电系统部件

熔断器隔离开关 (SASIL)

条形熔断器底座

条形熔断器隔离开关

熔断器底座

并列式熔断器隔离开关

60mm母排控制系统C-O-S-M-O



### 配电系统

低压配电系统



PC-COSM0001C

本公司保留技术修改的权力